

Tribological Behaviour of Al-Based Mmcs and Their Application in Automotive Industry

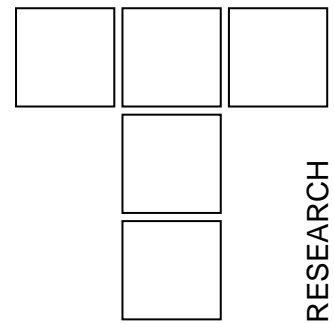

The use of different kind of composite materials is in constant growing over the years, because they have better physical, mechanical and tribological properties comparing to matrix materials. Composite materials based on light metals like Aluminium, Magnesium and Zinc, due to their low density, find application in many industries.

In automotive industry they are used for pistons, cylinders, engine blocks, brakes and power transfer system elements.

This paper considers the tribological properties of Al-based MMCs as a function of the manufacturing technologies and variation of shape, dimension and percentage of reinforcement material.

Keywords: Al-based MMCs, automotive industry, friction, wear

1. INTRODUCTORY CONSIDERATIONS

Composite material is a mixture of two or more materials or phases of the same material, insoluble in one another, possessing properties which are superior to any of the component materials.

Volume fraction of component materials should be above 5 % of total volume and their properties must be different from one another. Usually, volume fraction of one material is significantly higher than the volume fractions of the others and that material is called – matrix. Matrix can be ceramic, metal and polymer.

Reinforcements are usually fibres or particles of different orientation and shape (Fig. 1). The arrangement of the particles can be random, in most cases (Fig. 1a), or preferred, in the shape of sphere, cube or any close-to-regular geometrical form.

A fibrous reinforcements are characterized by its length and diameter so we distinguish, long (continuous) fibres (Figs. 1d and 1e) and short (discontinuous) fibres - whiskers (Figs. 1b and 1c). Arrangement can be, as well, preferred (Fig. 1b) and random (Fig. 1c), and often the direction of fibres is changed from one layer to another (Fig. 1e). Hybrids

are a newer type of composites and there we have two or more fibre types, or combined fibres and particles, mixed throughout the layers or in the same layer.

Two mostly used reinforcements are silicon carbide (SiC) and alumina (Al_2O_3), and variation of their shape, dimension and percentage have a great influence on the properties of MMCs.

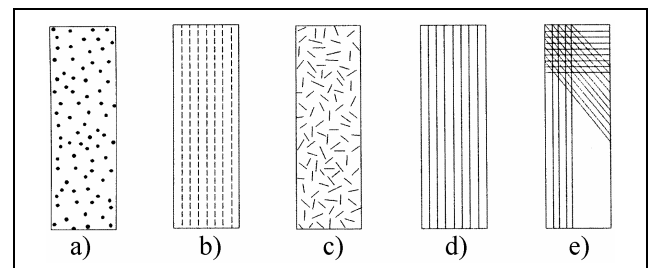

Figure 1: Shape and arrangement of reinforcements in composite materials

The use of different kind of composite materials is in constant growing over the years, because they have better physical, mechanical and tribological properties comparing to matrix materials. Composites based upon light metals, aluminium, magnesium and zinc, grace to their low density, are being applied in many industries, including the automotive. Among all these, aluminium based composites might be the most frequently used ones and extensive research has been performed on possibilities of their use for manufacturing of the tribomechanical components, so they will be analysed in the following text as representatives of the light metals based composites.

Aleksandar VENCL, Aleksandar RAC
University of Belgrade, Dept. of Mechanical
Engineering, Laboratory for Tribology, Kraljice
Marije 16, 11120 Belgrade 35, Serbia and
Montenegro,
Ilija Bobić, VINČA Institute of Nuclear Sciences,
Material Sciences Laboratory, 11001 Belgrade,
P.O. Box 522, Serbia and Montenegro

2. TECHNOLOGIES OF MANUFACTURING THE AL-BASED METAL MATRIX COMPOSITES (AL MMCS)

The Al MMCs are generally manufactured either by the powder metallurgy technique or some of the casting methods.

By using the powder metallurgy technique one can obtain the composite materials of the best mechanical and process properties. The shortcoming of this technique is its high cost, compared with the casting methods, so today it is used for manufacturing the specially assigned parts. Need for obtaining low cost products that can be produced in large series has induced the need for development and application of several casting methods [1, 2].

In order to attain favourable mechanical and process properties of the composite material it is necessary to ensure maximal transfer of properties between the matrix and reinforcement. The most important conditions to achieve that are attaining a sufficient bond between the matrix and the reinforcement and providing maximal strength between the matrix and the reinforcement [3].

Up to date, several casting techniques have been developed. Some of them (squeeze-casting, compocasting and vortex) are widely used in parts production. Others, like the centrifugal method, method of producing metallic foams and the directional solidification method, are, currently, in a limited extent use [1, 4, 5].

Squeeze casting method

The oldest and today the most frequently used method, primarily in the automotive industry, is squeeze casting. The principle schematic of this method is given in figure 2 [1].

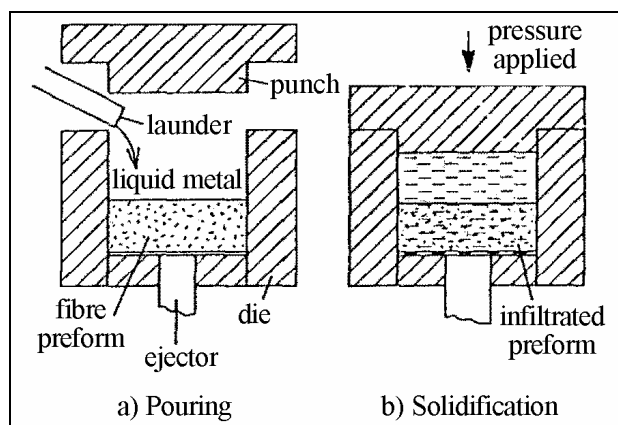

Figure 2: Scheme of the squeeze casting method

It is based upon the principle that melt of the matrix, metal or alloy, at high pressure (over 100 MPa) fills all the pores and channels of the preform, which should be porous enough to ensure optimal filling. This can assure favourable bond between the matrix and the reinforcement. Preforms are made of fibres or particles of reinforcement materials [1, 4].

A characteristic of this method is that liquid–solid phase change is very quick. Consequence of the non-equilibrium solidification is that favourable fine grain composite structure is attained.

Besides the favourably arranged reinforcement within the matrix and the strong bond between the matrix and the reinforcement, this method ensures smooth surface of the product as well. Since pressing operation is very rapid, high productivity is ensured that is of high practical significance. Shortcomings of the method are need for costly tools (tools withstanding high pressure and high temperature), and additional cost for tools maintenance, since each damage of a tool induces an error in product dimensions [1, 4].

Compocasting method

Compocasting method, together with rheocasting and thixoforming methods, belongs to the group of SMF (Semi Solid Forming) technologies that include reformation of hyper- and hypo-eutectic alloys in the semi-solid state [1, 6, 7]. Semi-solid melts exposed to shear forces behave as pseudoplastic non-Newtonian fluids, i.e. their viscosity varies depending upon the intensity of these forces [8]. This phenomenon enables infiltration of the reinforcement particles into the metallic matrix followed by the entrapment of particles or fibres and escaping to solve the wettability problem at the matrix-reinforcement boundary.

Compocasting method has several qualities. It is performed at lower operation temperatures and pressures compared to, e.g. squeeze casting method. This saves energy and extends the tool life. It enables favourable distribution of the reinforcement by varying the shear rate – mixing rate ratio. Also, optimal combination of parameters, as shear rate and cooling rate, can result in a favourable structure.

The main shortcoming of this method is its non-applicability for obtaining composites with the matrix out of pure metals and - eutectic alloys. However, in the area of producing the composites with the matrix based on alloys with the appropriate temperature semi-solid region, it is considered as one of the most prospective casting methods [1, 5, 6, 7].

Vortex method (Stirr casting)

Schematic of Vortex method is given in fig. 3 (in the pouring-through-bottom variant) [9].

Infiltration of the reinforcement is performed into the overheated melt (above the liquidus temperature analogously to classical casting), with stirring for attaining their favourable distribution. It is simply to perform and very productive. It is used mostly for producing composite casts, with pure metal and eutectic alloys matrices. Advantage of the Vortex method is enabling production of low price casts – composites of complex configuration and thin walls (large series, use of sand moulds, molds etc.) [1, 9]. Its basic limitation is necessity of solving the problem of reinforcement particles wettability in the matrix melt.

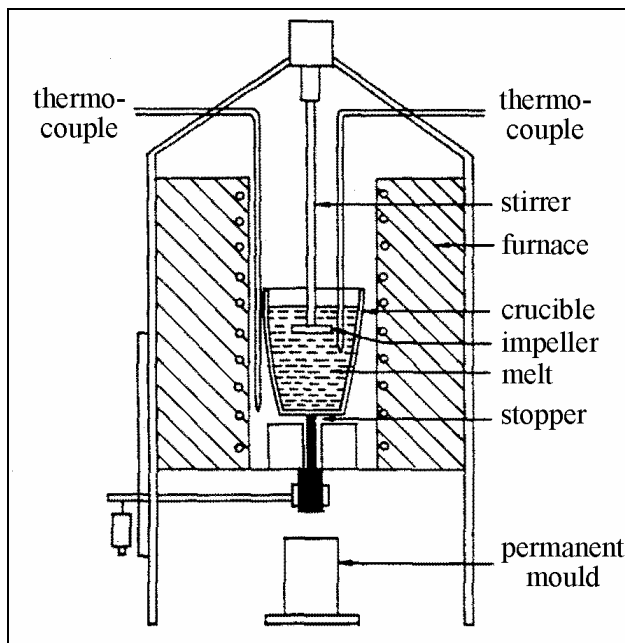

Figure 3: Scheme of Vortex method

3. PHYSICAL AND MECHANICAL PROPERTIES OF AL MMCs

Coefficient of thermal expansion is an important property for many applications and it is lower for composite materials compared to the matrix. This reduction is, partially, due to the fact that the coefficient of thermal expansion of reinforcement is two to three times less than its value for the matrix material. It should be noted that if the reinforcement is in the form of fibres, the coefficient of thermal expansion of the composite won't be the same in the direction of fibres and perpendicular to fibres.

Basic properties of SiC and Al₂O₃, the two most frequently used reinforcements, are given in table 1, and their influence on the mechanical properties of composites is given in table 2, showing the comparative values for some Al alloys with and without the reinforcement.

Table 1. Basic properties of SiC and Al₂O₃ reinforcements [10, 11]

Reinforcement	Density, kg/m ³	Young's modulus, MPa x 10 ³	Tensile strength, MPa
Fibres Al ₂ O ₃	3900	380	1400
Fibres Al ₂ O ₃ *	3300	380	1800
Particles SiC	3210	370	-
Fibres SiC**	2600	250	2200
Fibres SiC**	2400	280	2000

*Al₂O₃: 95 %; Al₂O₃ + SiO₂: >99 %

** different manufacturers materials

Generally, all physical and mechanical properties of composite materials are better compared to the matrix material, although when comparing the results one should keep in mind that Al MMCs are heterogeneous and often anisotropic materials. Young's modulus, for instance, measured in direction of reinforcement fibres is higher than for composites with particulate reinforcement, for the same volume of reinforcement. If Young's modulus is measured in direction perpendicular to fibres - the case is reversed.

Yield stress and tensile strength mostly increase with increasing volume fraction of reinforcement, although this is not necessarily the rule and for each particular use the optimal volume fraction of reinforcement should be determined.

Ductility of composite materials is far lower than for the matrix material. Among the factors which may play a role in this effect are matrix-reinforcement interface properties and possible reactions, the homogeneity of the reinforcement dispersion, the surface properties of the reinforcement, the cleanness of the matrix, the reinforcement and the whole processing route. Presence of porosity in the material additionally lowers the ductility.

Table 2. Mechanical properties of Al based alloys with and without the reinforcements [12, 13, 14]

Alloy	Young's modulus, MPa x 10 ³	Yield stress, MPa	Tensile strength, MPa	Elongation, %
1050A		71,5	134,2	21,6
1050A + 20% SiC	-	122,7	212,3	12,5
1050A + 20% SiFe	-	120	191,2	15,9
1050A + 20% Al ₂ O ₃	-	80,9	167	17,3
1050A + (10% SiFe-10% Al ₂ O ₃)	-	153	262	15,4
2014 (T6)	73	427	496	13
2014 + 10% Al ₂ O ₃ (T6)	84	483	517	3,3
2014 + 15% Al ₂ O ₃ (T6)	92	476	503	2,3
2014 + 20% Al ₂ O ₃ (T6)	101	483	503	1,0
2124 + 20% SiC (T4)	105	405	560	7,0
2124 + 25% SiC (T4)	116	490	630	2-4
2618 (T4)	70	222	470	16,4
2618 (T651)	70	418	445	7,2
2618 + 15% SiC (T4)	94	254	482	12,3
2618 + 15% SiC (T651)	95	484	503	4,1
A356 (T6)	-	230	290	13
A356 + 10% SiC (T61)	82	287	308	0,6
A356 + 15% SiC (T61)	91	329	336	0,3
A356 + 20% SiC (T61)	98	336	357	0,4
4047	57,5	-	303	-
4047 + 4 % C	64,2	-	250	-
4047 + 12% Al ₂ O ₃	71,5	-	301	-
4047 + (4% C-12 % Al ₂ O ₃)	79	-	287	-
6061 (T6)	69	286	310	12
6061 + 15% SiC (T6)	91	342	364	3,2
6061 + 20% SiC (T4)	98	405	460	7,0
6061 + 25% SiC (T4)	115	430	515	4,0
6061 + 10% Al ₂ O ₃ (T6)	81	296	338	7,5
6061 + 15% Al ₂ O ₃ (T6)	87	317	359	5,4
6061 + 20% Al ₂ O ₃ (T6)	98	359	379	2,1

4. TRIBOLOGICAL BEHAVIOUR OF AL MMCS

Numerous authors have investigated tribological properties of Al-based composite materials and have analysed different impacts.

First of all, influence of the type and properties of materials was analysed. Aluminium and its alloys: Al-Cu, Al-Si, Al-Mg-Si and Al-Zn were mostly used as the matrix, and SiC and Al₂O₃ of different size and volume fraction were mostly used as the reinforcements. Influence of additives (graphite) and surface roughness was analysed as well.

Aside from analysing the influence of different materials and composite manufacturing processes, investigations were performed on influence of different conditions (pressure, temperature, type of relative motion, with and without the lubricant).

Unfortunately, different authors have led investigations under different conditions, and this makes comparison of their results very difficult. A possible solution for comparison of results is use of wear mechanism maps. An example of such a map for 6061 Al-alloy reinforced with SiC whiskers is given in figure 4 [15].

Role of wear mechanism maps is in the approximate prediction of material behaviour and in comparison of results of the experiments depending on the testing conditions (normal load and sliding speed).

Differences in testing conditions can be overcome by establishing correlations of normalized values of testing parameters (wear rate, load and sliding speed) with the influential factors.

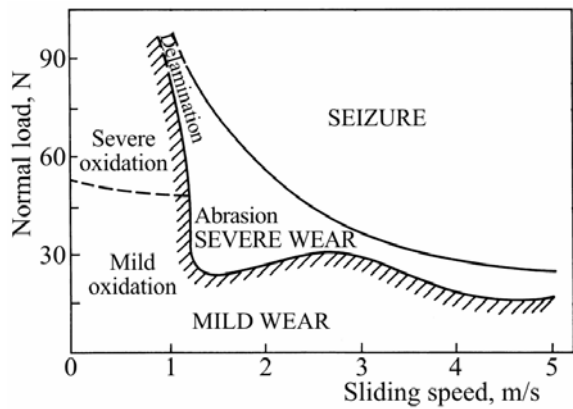

Figure 4: The empirical wear-mechanism map for Al alloy 6061 reinforced with SiC whiskers

Figures 5 and 6 shows how the normalized wear rate and normalized coefficient of friction depend on volume fraction of reinforcement in different Al alloys [13].

Normalized wear rate (composite wear rate / matrix wear rate) decreases with the increase of reinforcement volume fraction, and limit after which this becomes apparent is about 20 % [13, 16, 17]. Similar dependence on reinforcement volume fraction is obtained for the normalized coefficient of friction. Increase of reinforcement size reduces the wear rate as well (fig. 7) [18].

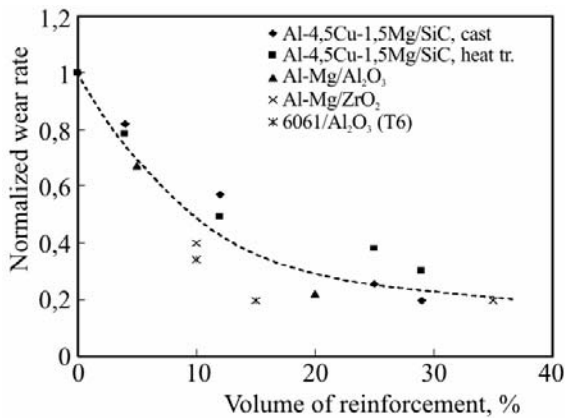

Figure 5: Normalized abrasive wear rate of some Al composites reinforced with hard particles

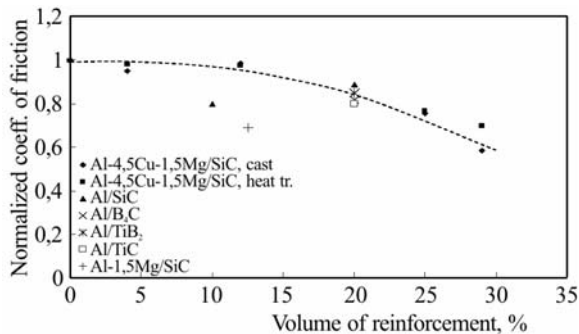

Figure 6: Normalized coeff. of friction of some Al composites reinforced with hard particles

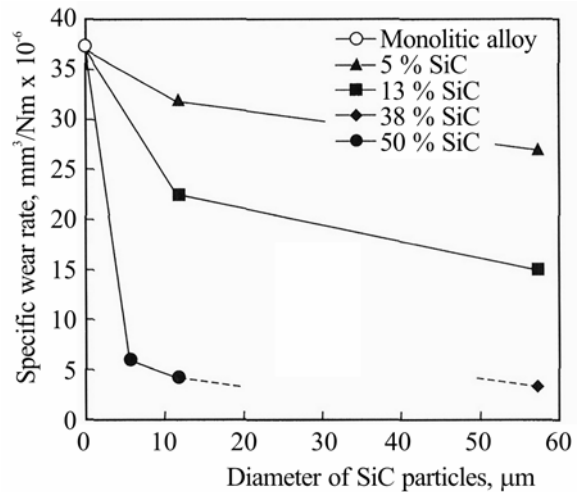

Figure 7: Dependence of specific wear rate and diameter of SiC particles for Al-Si-Cu alloy

This is characteristic for testing conditions where abrasive wear was dominant. Softer metal matrix material is usually worn away first, leaving the protrusions of the hard second phase of particulates or short fibre reinforcement which protect the metal matrix from further wear. For a certain critical volume fraction of the reinforcement, the metal matrix will be completely protected (fig. 8). Increase of the volume fraction and size of reinforcement both reduce the plastic deformation in the layer below the worn surface, which reduces the adhesive wear of the composite.

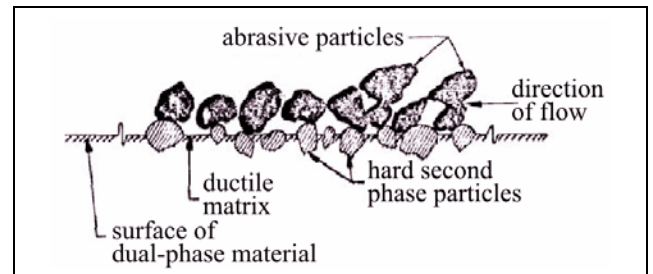

Figure 8: Schematic illustration of hard second phase particles protecting the ductile matrix from abrasion

Volume fraction of reinforcement can have opposite effect as well, i.e. its increase can induce the increase of the wear rate.

A group of authors from China [11] have varied volume fraction of Al₂O₃ fibres in the Al alloy 4047, in order to determine their optimal content. The account was taken of the dual effect of increasing the content of Al₂O₃ fibres (fig. 9). Higher content increases strength, load-bearing capacity and thermal stability and reduces plastic deformation of the matrix i.e. reduces the wear rate (ΔW_1), but higher content increases the probability for fracture and comminute of Al₂O₃ fibres, their spalling from

the surface and abrasion, i.e. increased wear rate (ΔW_2). The lowest value of the total wear rate (ΔW) was obtained for the 12 % volume fraction of Al_2O_3 fibres.

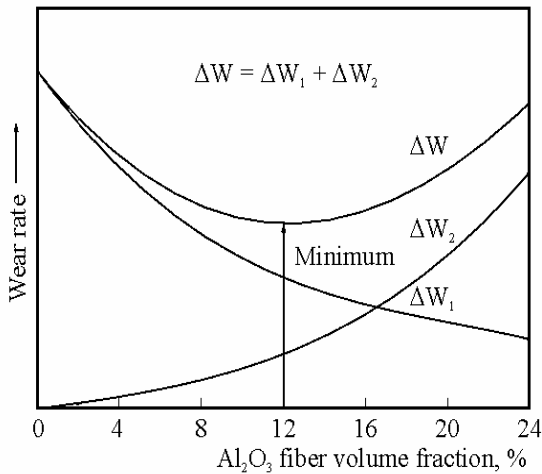

Figure 9: The schematic diagram of dual-effect of Al_2O_3 fibres on wear rate of Al alloy 4047

Influence of normal stress and contact temperature is such that their increase induces a steady wear rate increase, which is lower for composite materials than for the matrix material. Also, the appearance of critical values of load and temperature, above which the wear rate increases sharply, has been noted (figs. 10 and 11).

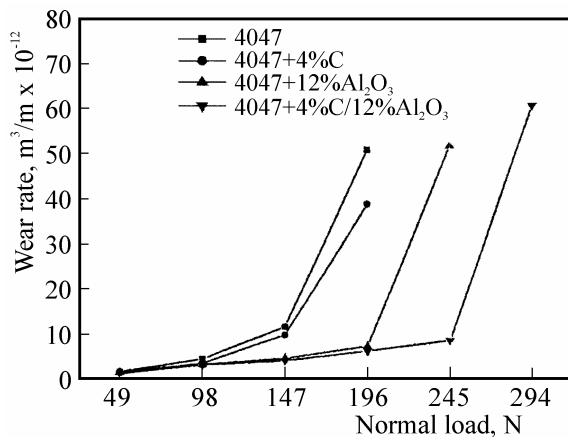

Figure 10: Dependence of wear rate on normal load for Al alloy 4047 [11]

At normal loads above the critical value, reinforcement is being fractured and separated from the matrix, and acted like abrasive, at temperatures above critical the surface layers soften and tested materials suffer the adhesive wear.

Presence of graphite in composites reduces the wear rate and coefficient of friction because graphite acts as lubricant when it is in contact area exposed to load [11, 18].

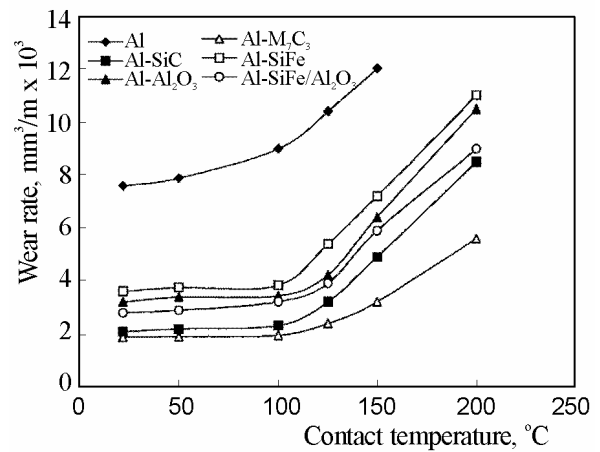

Figure 11: Dependence of wear rate on contact temperature for Al alloy 1050A [12]

A more detailed review of the used apparatus, materials and testing conditions can be found in the paper written by A. Vencel and A. Rac [19].

5. APPLICATION OF AL MMCS IN AUTOMOTIVE INDUSTRY

Basic requirements in engine industry, which are major driving forces for developing and implementing new materials, are reduction of fuel consumption and vehicle emissions. Aluminium and other light metals have lower density compared with the standard materials used in engine industry (grey cast iron and steel). Their utilization reduces mass, and increases the efficiency, and thus satisfies the basic requirements on fuel economy and vehicle emissions.

Unfortunately their tribological properties are not satisfactory, which limits their application in manufacturing the tribomechanical components. One of the possible solutions for this problem is use of Aluminium Metal Matrix Composites (Al MMCs). These materials, although being primarily developed for the needs of airplane and space industry, find an increased application in automotive industry, where they are utilized for manufacturing pistons, cylinders, engine blocks, brakes and power transfer system elements.

The present state and possibilities for wider application of Al MMCs have been reviewed in numerous studies and papers [13, 20, 21, 22].

Toyota Motor Co. developed in 1985 a diesel engine piston, in which a discontinuous fibre preform of Al_2O_3 , was infiltrated by squeeze casting into aluminium matrix [13].

Similar process, since 1990, is employing for producing the Honda Prelude 2,3 litre engine, in

which the cylinder liners, consisting of a hybrid of graphite and alumina fibres, were infiltrated during casting of the engine block. Wear resistance is superior to cast iron with a 20 % weight reduction of the engine block [21].

Aluminium MMC brake drums and rotors have been used in light-weight vehicles such as Lotus Elise, Volkswagen Lupo 3L, Chrysler Plymouth Prowler and General Motors EV-1. Advantage of weight savings (50 - 60 %), higher wear resistance, and higher thermal conductivity was achieved [13, 21].

Some global market studies show that, in 1999, the overall MMC market (not just aluminium-based) grew by 62 % of the volume in ground transportation applications. That studies projects that by 2004, this grow will continue at an average annual rate of 14,1 % [20].

6. CONCLUSION

Aluminium alloys have favourable physical and mechanical properties, primarily low density, but their tribological properties are unsatisfactory. One of the solutions is reinforcement of the basic alloy (matrix) and formation of composites. Most frequently used composites, in automotive industry, are Al-based alloys with silicon as the main alloying element reinforced with SiC and Al₂O₃.

These composite materials are produced by several standard technologies. Investigations are led aiming their improvement and cheaper production of composites with better properties.

The existing composite materials, compared to the matrix, have shown better physical, mechanical and tribological properties (wear resistance and coefficient of friction) both at room and at elevated temperatures. Investigations were mostly model-type and they have led only to correlations among the quantities, the real results can be obtained only in service-type investigation. The investigations of properties depending upon the counterpart contact material are less numerous but also relevant for creating the complete image of a material behaviour.

Use of composite materials in automotive industry is still increasing. Up to date, they have been used for manufacturing pistons, cylinders, engine blocks, brakes and power transfer system elements. Performance benefits of using the Al MMCs in automotive industry are reduced weight and improved wear resistance, together with better thermal conductivity comparing to the traditional materials (steel and gray cast iron). In the future, applications of Al MMCs are likely to continue to grow because of the continuing pressures to reduce vehicle weight and

levels of vehicle emissions and to increase fuel economy.

REFERENCES

- [1] Zhu Z., *A Literature Survey on Fabrication Methods of Cast Reinforced Metal Composites*, Cast Reinforced Composites, ASM Internat. USA, 1988, Proceedings, 93-99
- [2] Mitkov M., Božić D. i Vujović Z., *Metalurgija praha*, BMG, Beograd, 1998, 419-423
- [3] Rühle M. and Evans A.G., *Structure and chemistry of metal/ceramic interfaces*, Materials Science and Engineering A, 107, 1989, 187-197
- [4] Rohatgi P. and Asthana R., *Solidification Science in Cast MMCs: The influence of Merton Flemings*, JOM, 53, 9, 2001, 9-13
- [5] Rohatgi P., *Cast Aluminum-Matrix Composites for Automotive Applications*, JOM, 42, 4, 1991, 10-15
- [6] Mehrabian R., Riek R. and Flemings M., *Preparation and Casting of Metal-Particulate Non-Metal Composites*, Metall. Trans., 5, 1974, 1899-1905
- [7] Hoskins F., Folgar Portillo F., Wunderlin R. and Mehrabian R., *Composites of Aluminium Alloys, Fabrication and Wear Behaviour*, Journal of Materials Science, 17, 2, 1982, 477-498
- [8] Spencer D., Mehrabian R. and Flemings M., *Rheological Behaviour of Sn-15 Pct Pb in the Crystallization range*, Metall. Trans., 3, 1972, 1925-1932
- [9] Ghosh P.K. and Ray S., *Influence of Process Parameters on the Porosity Content in Al(Mg)-Al₂O₃ Cast Particulate Composite Produced by Vortex Method*, AFS Transactions, 88, 1988, 775-782
- [10] Druždžel A., *Friction and wear of Al-based MMCs under conditions of oscillatory relative motion*, PhD thesis, Delft University of Technology, Faculty of Mechanical Engineering and Marine Technology, 1996
- [11] Jun D., Yao-hui L., Si-rong Yu and Wen-fang L., *Dry sliding friction and wear properties of Al₂O₃ and carbon short fibres reinforced Al-12Si alloy hybrid composites*, Wear, 257, 2004, 930-940
- [12] Korkut M.H., *Effect of particulate reinforcement on wear behaviour of aluminium*

- matrix composites*, Materials Science and Technology, 20, 1, Jan 2004, 73-81
- [13] Prasad S.V. and Asthana R., *Aluminum metal-matrix composites for automotive applications: tribological considerations*, Tribology Letters, 17, 2004, 445-453
- [14] Martin A., Martinez M.A. and LLorca J., *Wear of SiC-reinforced Al-matrix composites in the temperature range 20-200°C*, Wear, 193, 1996, 169-179
- [15] Lim S.C., *Recent developments in wear-mechanism maps*, Tribology International, 31, 1998, 87-97
- [16] Sannino A.P. and Rack H.J., *Dry sliding wear of discontinuously reinforced aluminum composites: review and discussion*, Wear, 189, 1995, 1-19
- [17] Venkataraman B. and Sundararajan G., *The sliding wear behaviour of Al-SiC particulate composites - I. Macrobehaviour*, Acta mater., 44, 2, 1996, 451-460
- [18] Zou X.G., Miyahara H., Yamamoto K. and Ogi K., *Sliding wear behaviour of Al-Si-Cu composites reinforced with SiC particles*, Materials Science and Technology, 19, 11, Nov 2003, 1519-1526
- [19] Vencl A. i Rac A., *New wear resistant Al based materials and their application in automotive industry*, MVM – International Journal for Vehicle Mechanics, Engines and Transportation System, 30, Special Edition, December 2004, 115-139
- [20] *Aluminum Metal Matrix Composites Technology Roadmap*, Technologies Research Corporation, TRC Document 0032RE02, May 2002
- [21] DeSapio V., *Aluminum Metal Matrix Composites Gaining Greater Market Acceptance*, Industry Trade and Technology Review, March 2002, 37-49
- [22] Surappa M.K., *Aluminium matrix composites: Challenges and opportunities*, Sādhanā, 28, 1 & 2, February/April 2003, 319–334